

PERSIANA

**SCURO
ALLA
VENETA**

CASSONETTO
MEDITERRANEO

CASSONETTO
RISTRUTTURAZIONE

SISTEMI OSCURANTI
COMFORT TRA TRADIZIONE E STILE

ALPHACAN
INNOVATIVE PROFILES & SOLUTIONS

A MEMBER OF



ALPHAPRO



ITALIANO



PERSIANA

- Sistema oscurante disponibile con lamelle fisse oppure orientabili
- Design ed estetica versatili, con elevata resistenza agli agenti atmosferici
- Soluzione tecnica sviluppata da Alphacan che garantisce un risultato ottimale sulle giunzioni agli angoli

SISTEMA	PROPRIETÀ	VALORE TEST
PERSIANA	Resistenza al carico del vento	Classe 6
PERSIANA	Classe di trasmittanza dell'energia solare gtot	Classe 4

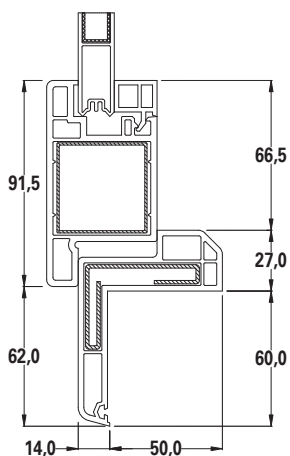
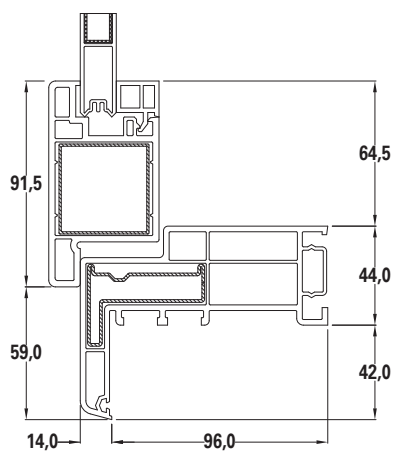
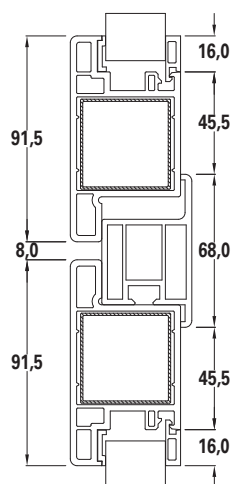
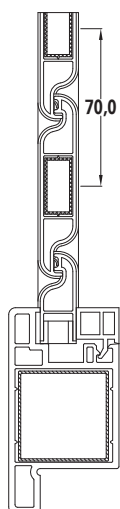

TIPOLOGIE COSTRUTTIVE

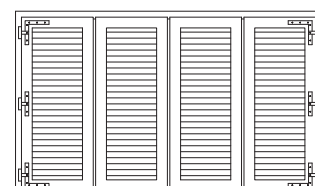
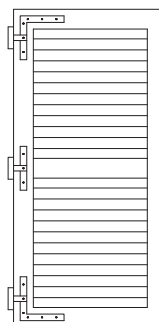
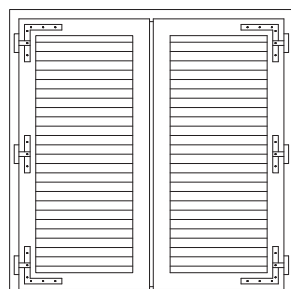
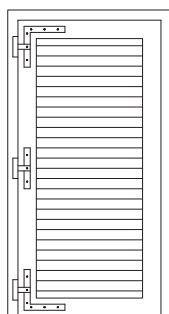
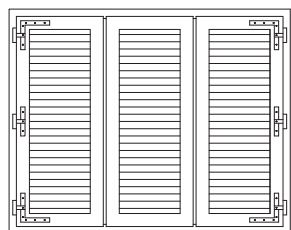



SCURO ALLA VENETA

- Sistemi di chiusura che riproducono antiche forme regionali di oscuramento
- Realizzabile con doghe modulari accoppiate verticalmente, senza snodi intermedi
- Dotato di un rinforzo metallico che conferisce elevata stabilità all'anta dello scuro
- La modanatura in bassorilievo ne impreziosisce l'estetica e rende il risultato finale pratico e affidabile



SISTEMA	PROPRIETÀ	VALORE TEST
SCURO	Resistenza al carico del vento	Classe 6

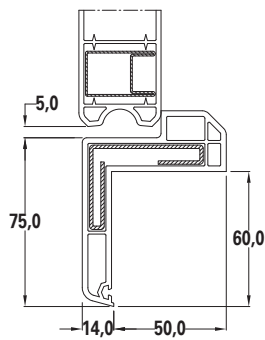
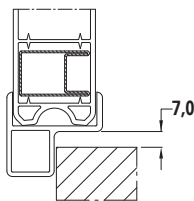
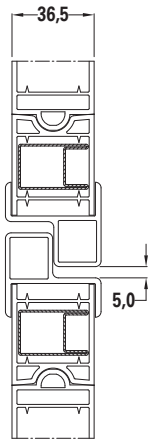
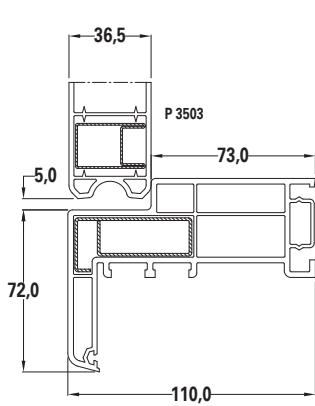

TIPOLOGIE COSTRUTTIVE

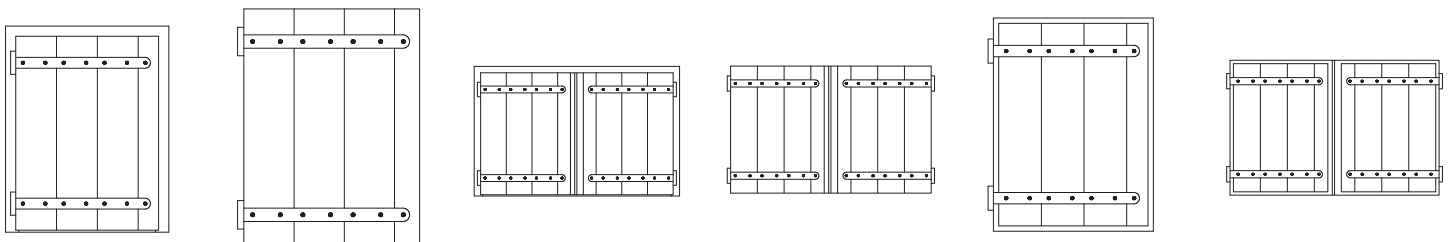



PERSONALIZZA
IL TUO AMBIENTE SU
www.alphacan-mydesign.com

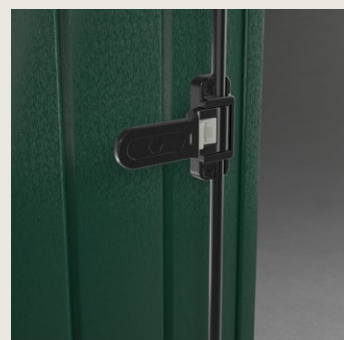



Eleganti, resistenti e personalizzabili

con un'ampia gamma di colori e finiture di prestigio, i sistemi oscuranti ALPHACAN non hanno bisogno di manutenzione e si adattano perfettamente a qualsiasi contesto.

Realizzati con PVC di alta qualità e progettati in maniera innovativa, rappresentano una scelta sostenibile e durevole, garantendo una protezione totale dagli agenti atmosferici e contribuendo a ridurre gli sprechi energetici e le spese in bolletta.





CASSONETTO MEDITERRANEO

- Cassonetto monoblocco particolarmente adatto alle nuove costruzioni
- Elevate prestazioni di isolamento termo-acustico
- Abbinabile a vari tipi di movimentazione, anche motorizzata

SISTEMA	PROPRIETÀ	TIPOLOGIA	VALORE TEST
CASSONETTO MEDITERRANEO	Trasmittanza (U_{sb})	Standard	2,7 W/m ² K
		Iso	0,99 W/m ² K
	Acustica (R_w)	Standard	30 dB
		Iso	32 dB

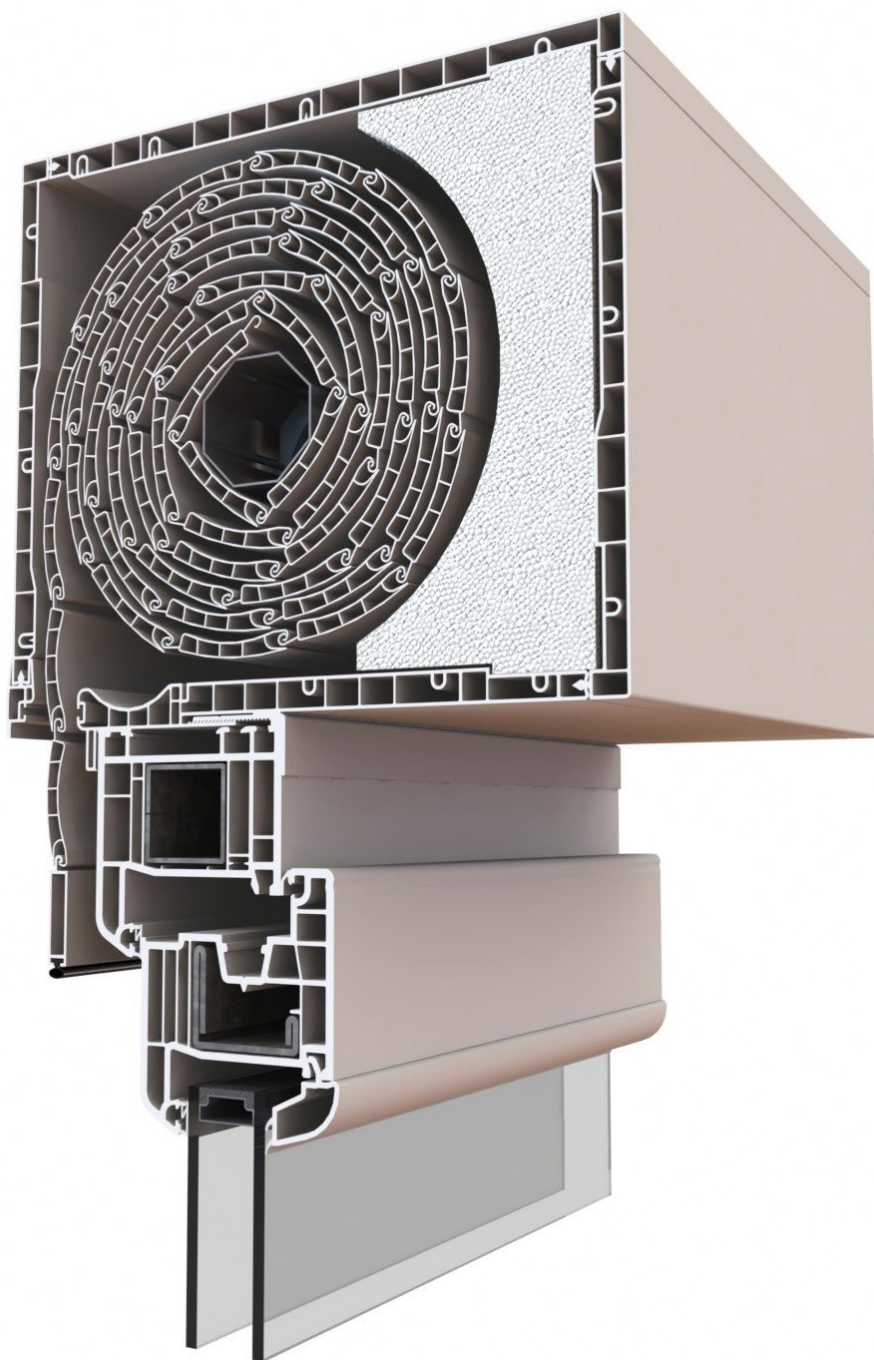
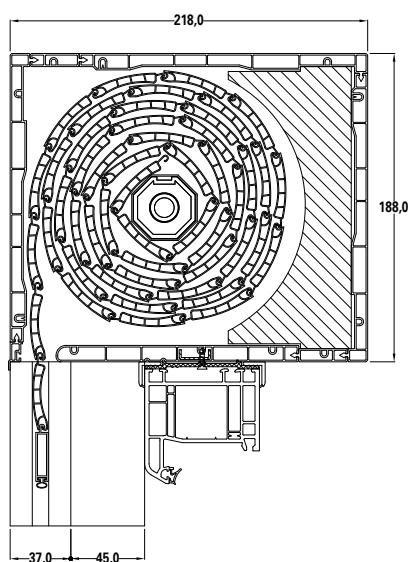
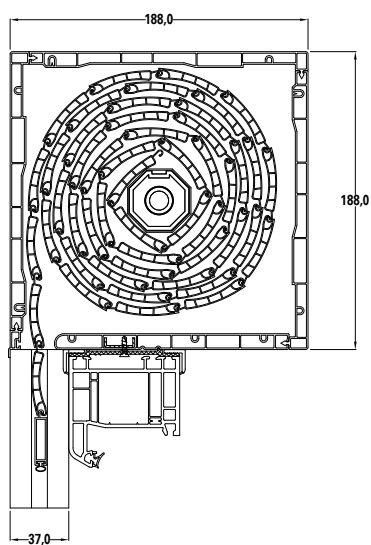



CASSONETTO RISTRUTTURAZIONE

- Sistema particolarmente indicato per la ristrutturazione
- Adatto a contenere avvolgibili anche di grandi dimensioni, grazie alla particolare conformazione geometrica dei componenti
- Perfettamente abbinabile ai serramenti poichè realizzabili con le stesse finiture
- Eccellenti prestazioni di isolamento termoacustico



SISTEMA	PROPRIETÀ	TIPOLOGIA	VALORE TEST
CASSONETTO RISTRUTTURAZIONE	Trasmittanza (U_{sb})	Frontale XPS 24 mm	1,6 W/m ² K
		Frontale XPS 40 mm	1,4 W/m ² K
		Frontale XPS 24 mm e strati laterali EPS 20 mm	1,2 W/m ² K
		Frontale XPS 40 mm e strati laterali EPS 20 mm	1,0 W/m ² K

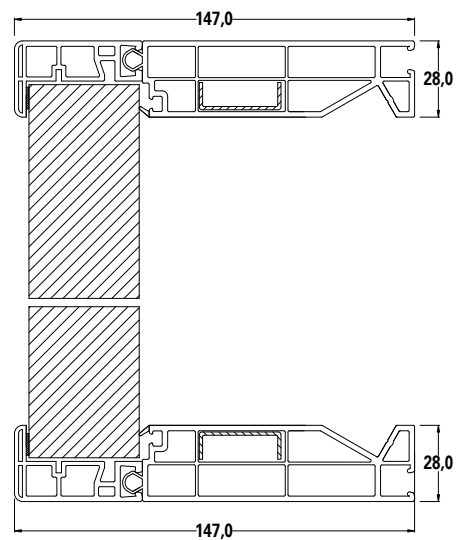
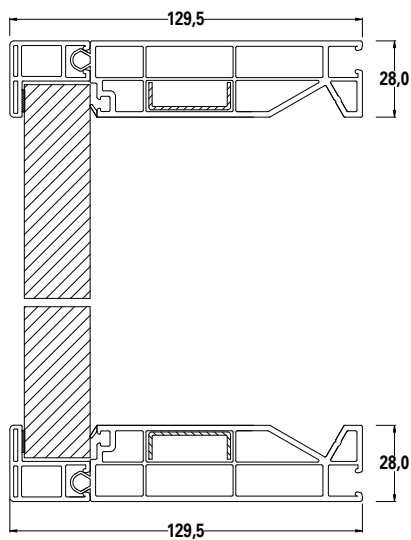
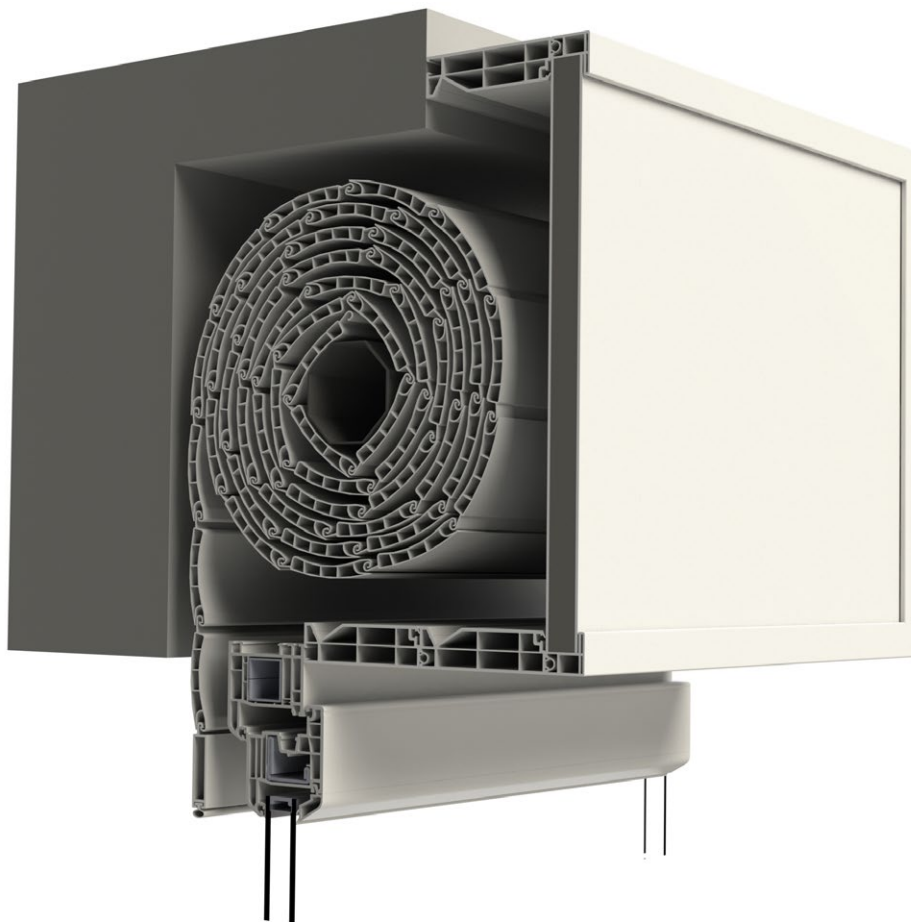



BROSCURITA - 2024
Dipartimento Marketing & Comunicazione Alphasan - Design UJTGS Alphasan

ALPHACAN
INNOVATIVE PROFILES & SOLUTIONS

A MEMBER OF **ALPHAPRO**

PRODUTTORE AUTORIZZATO ALPHACAN

Sede e Stabilimento
Via San Sisto, 24 - I-38062 Arco (TN)
Tel. +39 0464 587 500

info@alphacan.it www.alphacan.com

